

Revision No.	Location	Change description	Name	Date
.

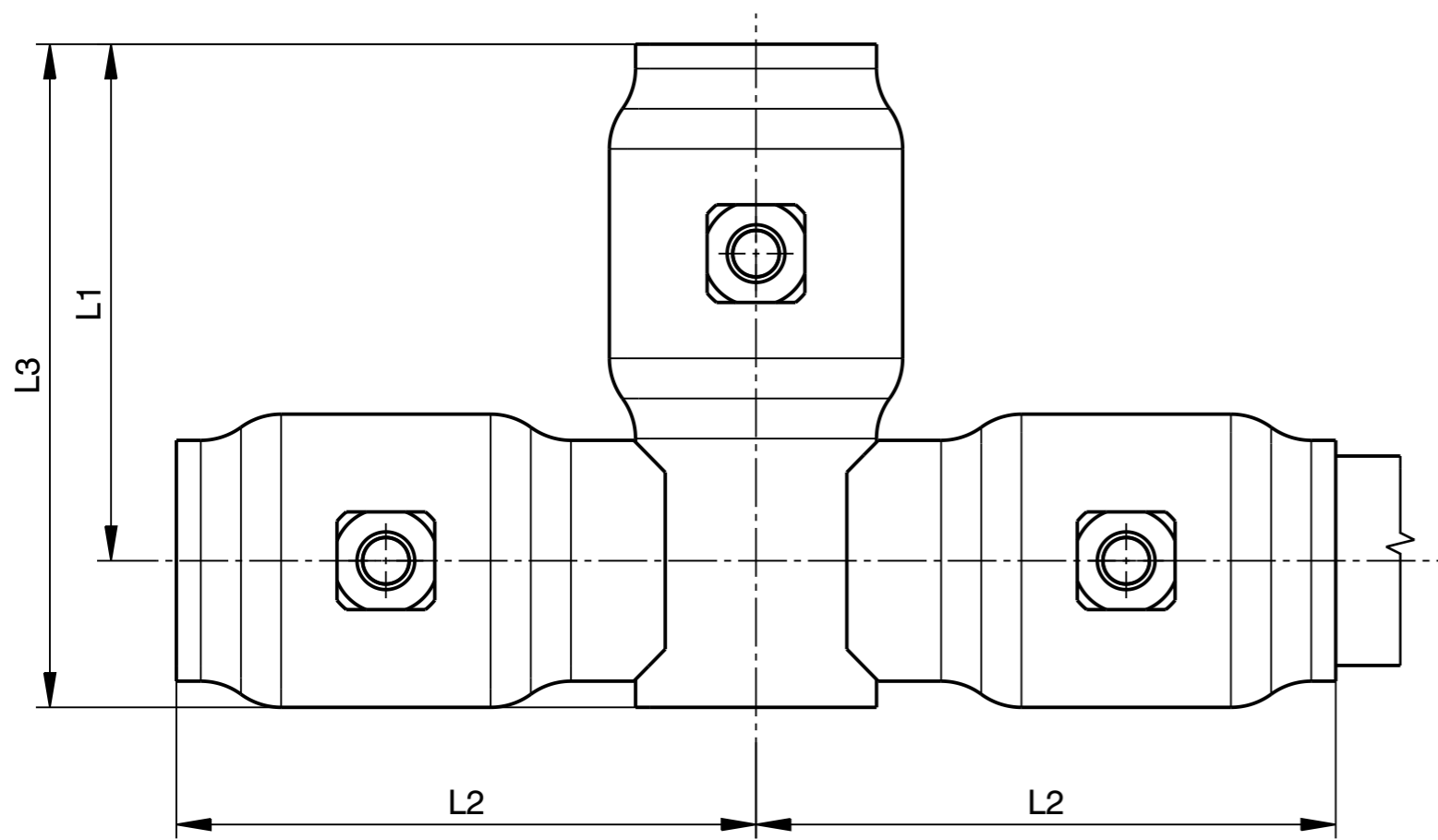
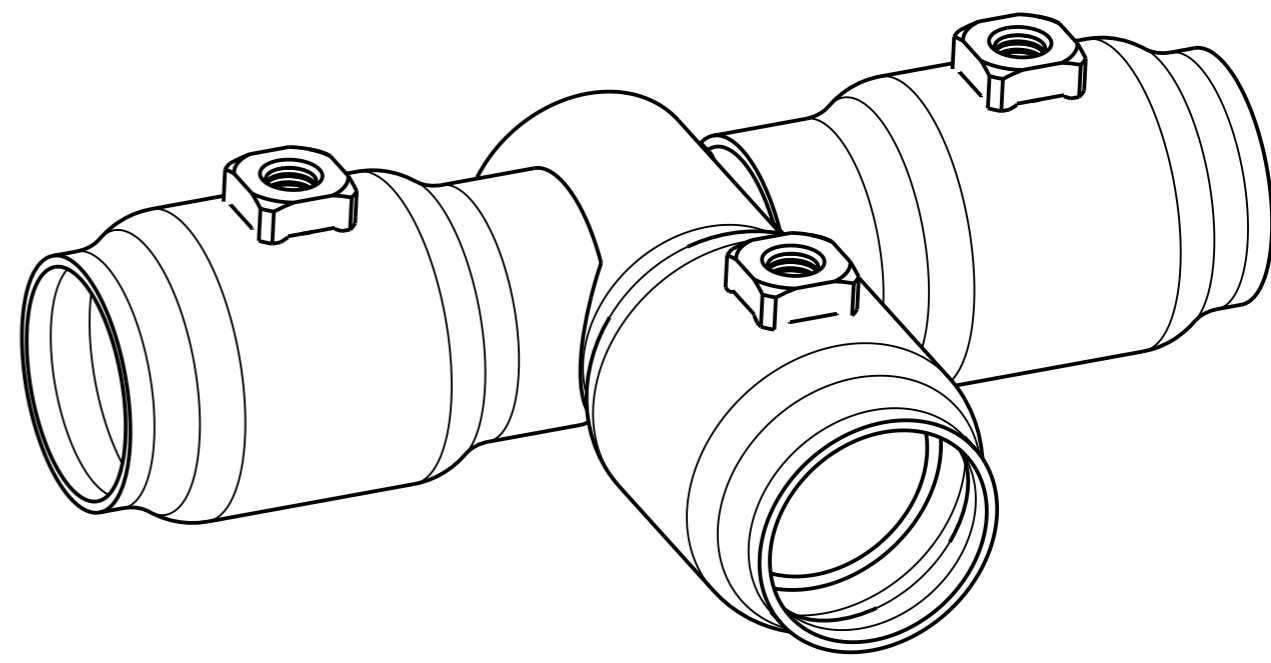
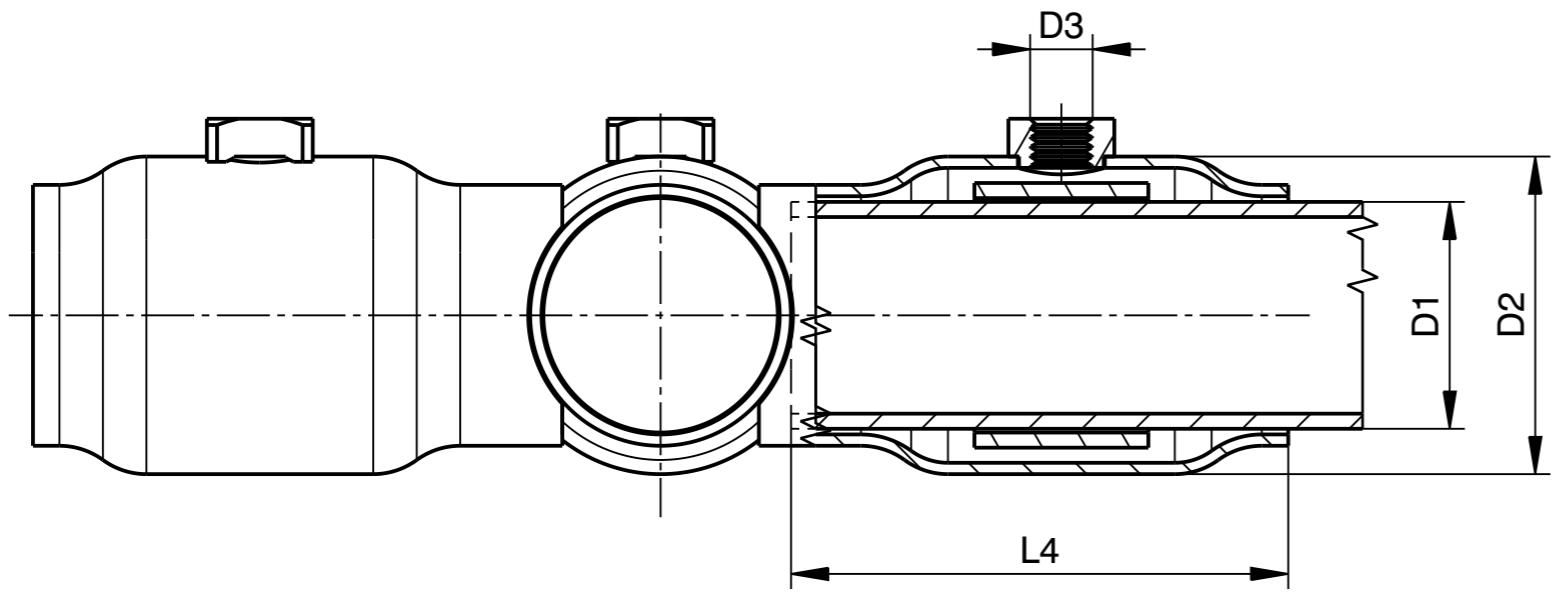

Ritning	D1	D2	D3	L1	L2	L3	L4
30EA031	30	42	M8	74	83	95	66
35EA031	35	48	M8	86	98	110	78

Symbols, designations and general drawing methods STD 5023,503 and STD 101-0005		View placement Reference arrow method: ISO 128-30:2001	
Document title			
Document type DRAWING			
Scale 1:1	Drawn Ola Nilsson	Date 2014-07-25	
Document No 30-35EA031		Revision No.	Sheet No 1/1